

COMODA SOLUZIONE DA USARE QUANDO L'ENTRATA E L'USCITA DAL MONTAUTO SONO OPPOSITE. IDEALE ANCHE NEL CASO VI SIA LA NECESSITA DI UNA DOPPIA USCITA AL PIANO INTERRATO.

CONVENIENT SOLUTION TO BE USED WHEN ENTRY AND EXIT TO THE CARLIFT ARE OPPOSITE. IDEAL ALSO IN CASE OF NEED2 EXIT AT THE LOWER LEVEL

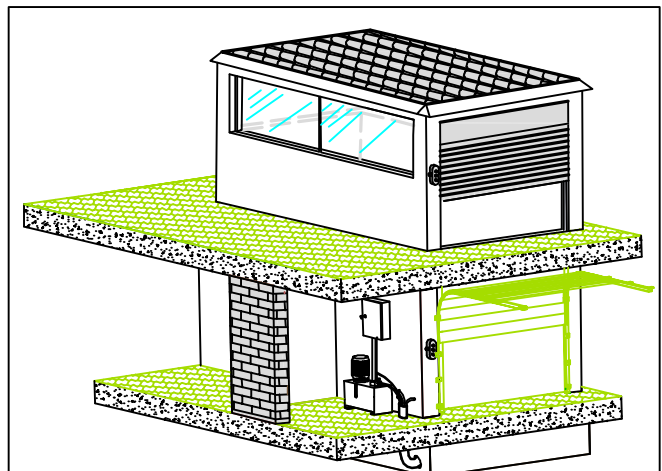

SOLUZIONE IDEALE IN GRADO DI CONFERIRE ALL'IMPIANTO UNA TOTALE RISERVATEZZA GARANTENDO UNA TOTALE PROTEZIONE.

CONVENIENT SOLUTION ABLE TO GIVE TO THE STRUCTURE A COMPLETE PRIVACY AND ASSURE A TOTAL PROTECTION TOO

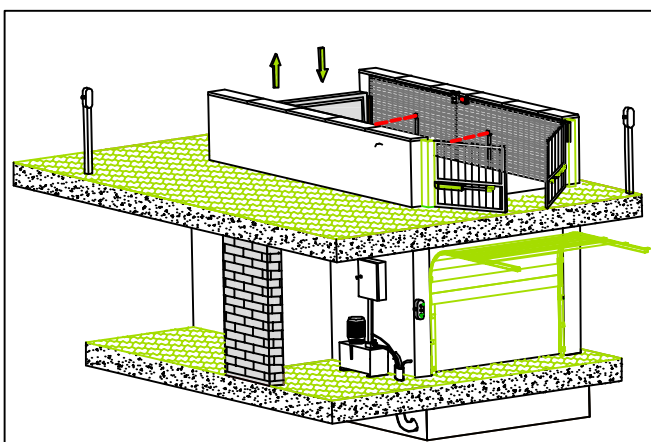

SOLUZIONE STUDIATA LA' DOVE VI SIA LA NECESSITA DI AVERE UN PASSAGGIO LIBERO IN ENTRAMBE LE DIREZIONI AL PIANO TERRA.

PLANNED SOLUTION WHERE THERE IS THE NECESSITY TO HAVE GOT A FREE TRANSIT IN BOTH DIRECTION AT THE GROUND LEVEL

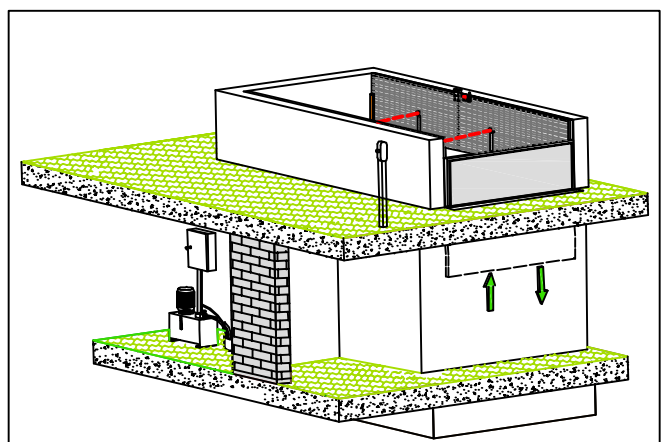

OTTIMA SOLUZIONE IN GRADO DI EVITARE INGOMBRI ESTERNI DOVUTI ALL'APERTURA DELLE ANTE DI UN CLASSICO CANCELLO

OPTIMAL SOLUTION TO AVOID EXTERNAL ENCUMBERED CAUSED TO THE SPREAD OF THE CLASSIC GATE SHUTTERS

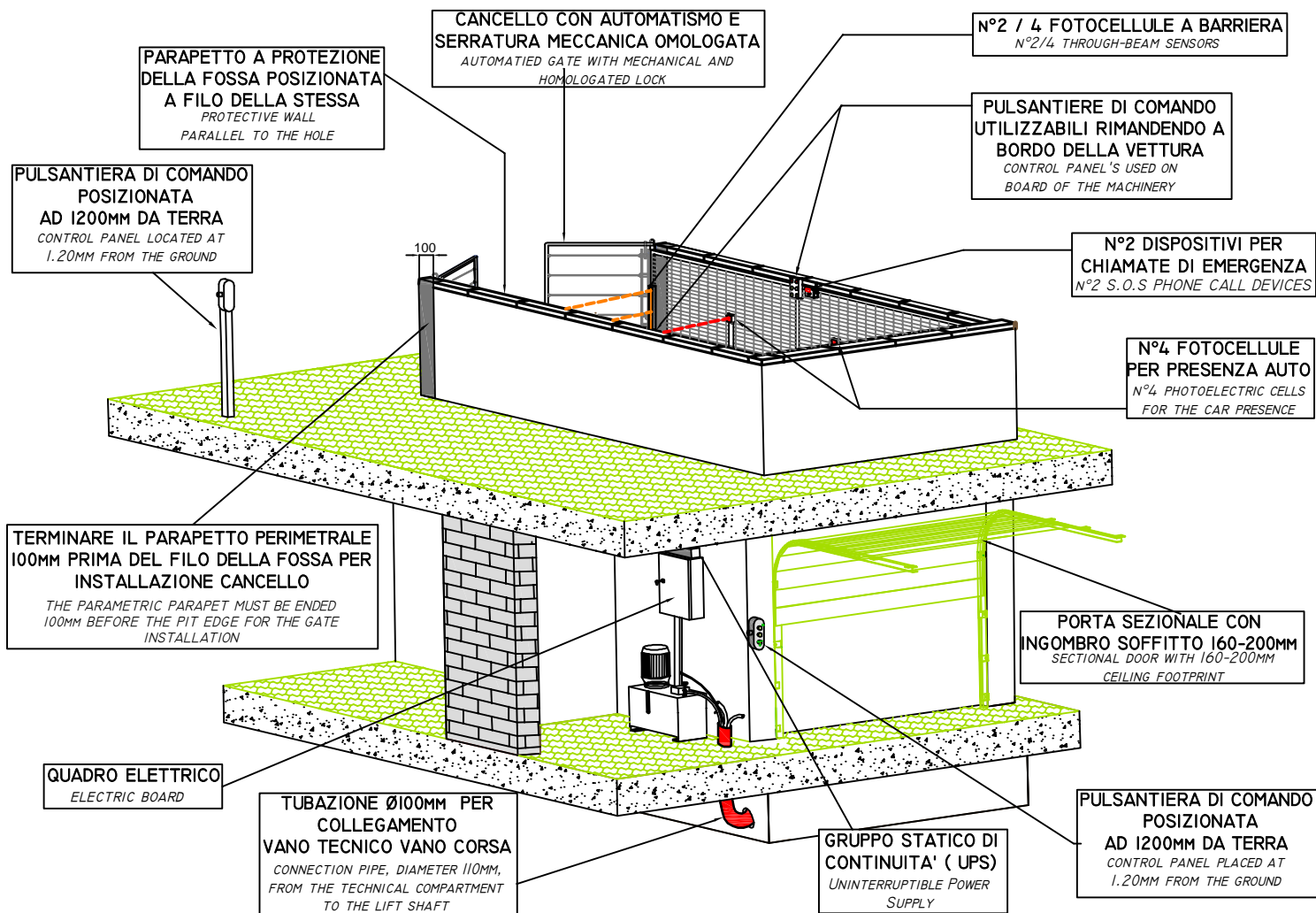

COMPONENTI DI SERIE

 <p>UPS AD INTERVENTO AUTOMATICO PER GARANTIRE LA MANOVRA DI DISCESA E APERTURA PORTA ANCHE IN MANCANZA DI TENSIONE UPS WITH AUTOMATIC INTERVENT TO ASSURE THE LOWERING MANEUVER AND THE DOOR OPENING ALSO IN CASE OF POWER FAILURE</p>	 <p>FOTOCELLULE INSTALLATE IN POSIZIONE CENTRALE DELLA PIATTAFORMA PER GARANTIRE IL FUNZIONAMENTO SOLO CON VETTURA A BORDO PHOTOCELLS INSTALLED IN THE CENTRE OF THE PLATFORM TO ASSURE THE FUNCTIONING ONLY WITH CAR ON BOARD</p>	 <p>BARRIERA DI SICUREZZA A FOTOCELLULA H 70CM PER PROTEZIONE LATI CARICO / SCARICO SAFETY BARRIER WITH PHOTOCELL AT 70CM HEIGHT TO PROTECT LOADING/DOWNLOADING SIDES</p>	 <p>SISTEMA DI CHIAMATA TELEFONICA TELESOCCORSO (OPTIONAL CON SCHEDA GSM) S.O.S. PHONE CALL DEVICE (GSM CARD OPTIONAL)</p>	 <p>CHIUSURE AI PIANI MOTORIZZATE COMPLETE DI INTERRUITTORE DI SICUREZZA A PONTE ASPORTABILE DOOR LOCATED AT EACH FLOOR WITH REMOVING SAFETY KEY</p>
---	--	---	--	--

PIANO TERRA: POSIZIONE DEL CANCELLO
GROUND LEVEL: GATE'S POSITION

COLONNA DI SOSTEGNO DEI BATTENTI. TERMINARE IL PARAPETTO PERIMETRALE 100MM PRIMA DEL FILO DELLA FOSSA
SHUTTER COLUMNS. THE PARAMETRIC PARAPET MUST BE ENDED 100MM BEFORE THE PIT EDGE

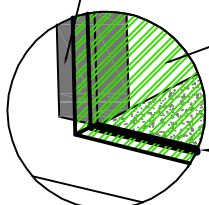

CANCELLO CHIUSO A FILO DEL VANO
CLOSED GATE IN LINE WITH THE EXTREME PIT'S EDGE

FILO INTERNO DEL VANO
INTERNAL PIT'S EDGE

PIANO INTERRATO: POS. PORTA SEZIONALE
LOWER LEVEL: SECTIONAL DOOR

GUIDA DELLA PORTA SEZIONALE FISSATA AL TELAIO DI SOSTEGNO
SECTIONAL DOOR LANE FIXED TO THE SUPPORT FRAME

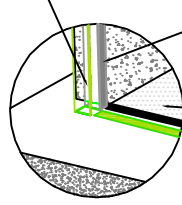

TELAIO DI SOSTEGNO COMPOSTO DA MONTANTI E VELETTA PER SOSTENERE LA PORTA SEZIONALE
SUPPORT FRAME COMPOSED BY A HORIZONTAL STEEL PLATE AND TWO POSTS TO SUPPORT THE SECTIONAL DOOR

FOSSA PIT

N.B. TERMINARE I MURI LATERALI IN LINEA CON IL FILO DELLA FOSSA
N.B. ENDING THE SIDEWALLS FINISH WITH THE PIT

PULSANTIERE DI COMANDO UTILIZZABILI RIMANDENDO A BORDO DELLA VETTURA

CONTROL PANELS WHICH WORK ONLY WITH "MAN PRESENT" TO START UP REMAINING ON THE CAR

N°2 DISPOSITIVI PER CHIAMATE DI EMERGENZA

N°2 DEVICES FOR EMERGENCY CALLS

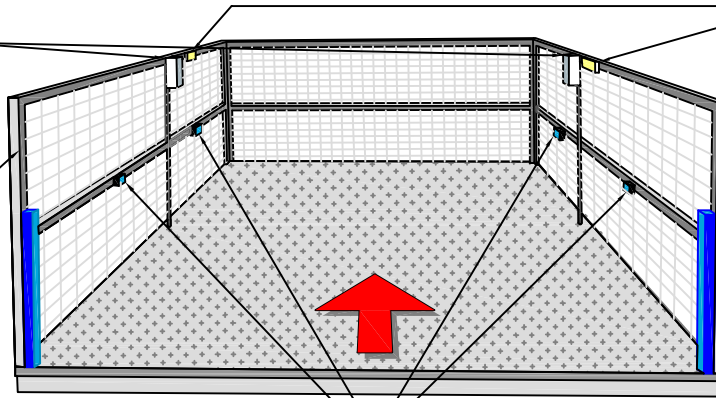

PROTEZIONE CON TELAIO ZINCATO A CALDO CON RETE MICROFORATA

PROTECTION COMPOSED BY STRUCTURE IN HOT GALVANIZED STEEL AND PERFORATED NET

N°2 / 4 FOTOCELLULE A BARRIERA IN ENTRATA E IN USCITA DAL PIANALE.

N°2/4 THROUGH-BEAM SENSORS

N°4 FOTOCELLULE PER CONFERMARE LA PRESENZA DELLA VETTURA

N°4 PHOTOELECTRIC CELLS FOR THE CAR PRESENCE

OPTIONAL



RESISTENTE ED ELEGANTE, OFFRE IL MASSIMO DEL COMFORT E SI ABBINA MERAVIGLIOSAMENTE CREANDO UN'OASI SIMBIOTICA CON L'AMBIENTE CIRCOSTANTE

HIGH RESISTANT AND ELEGANT SOLUTION TO COVER OUR PLATFORM RESPECTING THE ENVIRONMENT



IL PVC VIENE IMPIEGATO PER RIVESTIRE I PIANALI POICHE CONSENTE DI REALIZZARE QUALSIASI TIPO DI DESIGN CON UN PESO RIDOTTO E UNO SPESSORE MINIMO (min. 5mm - max 25mm)

PVC IS EMPLOYED TO COVER GREENPARK'S PLATFORMS BECAUSE YOU CAN REALIZED WITH IT EVERY KIND OF SOLUTION ALSO WITH ITS REDUCED WEIGHT AND MINIMUM THICKNESS



IL PIANALE DEL MONTAUTO PUO' ESSERE RIVESTITO CON LAMIERE DI ALLUMINIO ANTISCIVOLO MANDORLATE.

THE PLATFORM CAN BE COVERED WITH ANTISLIP ALUMINIUM SHEETS



TELECOMANDO CON COMANDI AD AZIONE MANTENUTA FUNZIONANTE CON SEGNALE RICEVITORE

REMOTE CONTROL WITH COMMANDS IN MAINTAINED ACTION WORKING WITH SIGNAL RECEIVER



DISPOSITIVO TELEFONICO FUNZIONANTE CON SCHEDA GSM IN ASSENZA DELLA LINEA TELEFONICA FISSA

TELEPHONE DEVICE WORKING WITH GSM CARD IN WITHOUT THE TELEPHONE LINE

LA GREEN PARK SRL FORNIRA' AL CLIENTE TUTTI GLI SCHEMI NECESSARI PER LA PREDISPOSIZIONE IN OPERA DELLE TUBAZIONI CORRUGATE UTILI PER IL COLLEGAMENTO TRA I VARI AUTOMATISMI E LA ZONA CENTRALINA.

GREEN PARK SRL SUPPLIES ALL THE DRAWINGS NECESSARY TO PREDISPOSE THE CORRUGATED PIPE-LINE USEFUL FOR THE CONNECTION BETWEEN AUTOMATISM AND THE POWER UNIT ZONE



LARGHEZZA WIDTH 95MM
ALTEZZA HEIGHT 180MM
SPESSORE THICKNESS 80MM

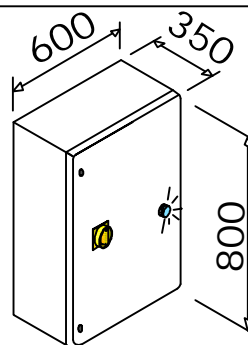

QUADRO MACCHINA CONFORME ALLA NORMA CEI-EN 60439-1 CEI 17-13 / I
ELECTRICAL BOARD IN ACCORDING WITH THE LAW CEI-EN 60439-1 CEI 17-13 / I

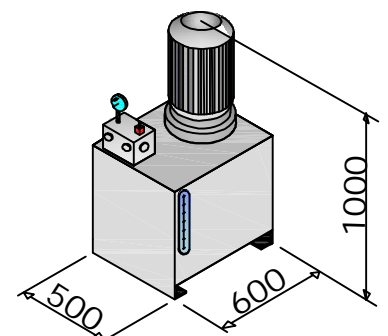

CENTRALINA IDRAULICA CONFORME ALLE NORME DELLA DIRETTIVA MACCHINE 2006 / 42 / CE
HYDRAULIC UNIT IN ACCORDING WITH THE LAW 2006 / 42 / CE

MOTORE TIPO KIND OF ENGINE	POTENZA POWER		TENSIONE ELETTRICA ELECTRIC VOLTAGE (V)	GIRI MOTORE ENGINE RMP (g/1')	ASSORB. SPUNTO STARTING ABSORP. (A)	ASSORB. A REGIME FUNCTIONING ABSORP. (A)
	(kW)	(HP)				
centralina UNIT	3	4	380 Volt	1400	11.5	6-7
centralina UNIT	4	5.5	380 Volt	1400	14.5	9-10
centralina UNIT	3	4	220 Volt	1400	16-18	12-14

Le seguenti quote sono riferite al modello **CMC COVER B1FREE LIGHT "CONDUCENTE A BORDO"**
The following amounts relate to the model **CMC COVER B1FREE LIGHT DRIVER ON BOARD**

VISTA IN PIANTA
MAP VIEW

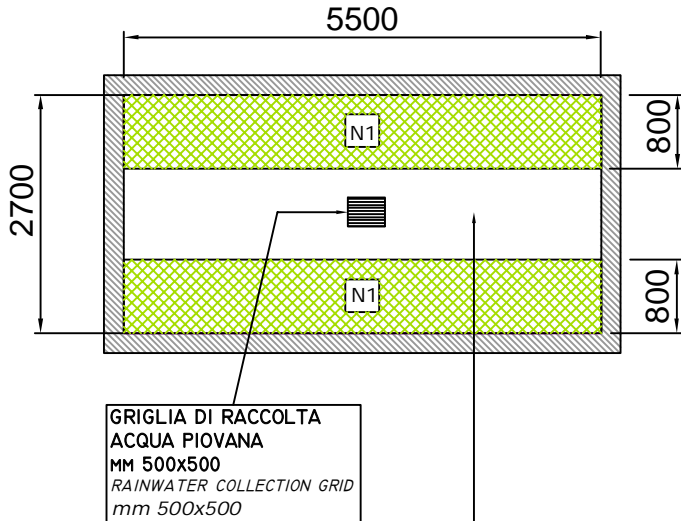

SEZIONE FRONTALE
FRONTAL VIEW

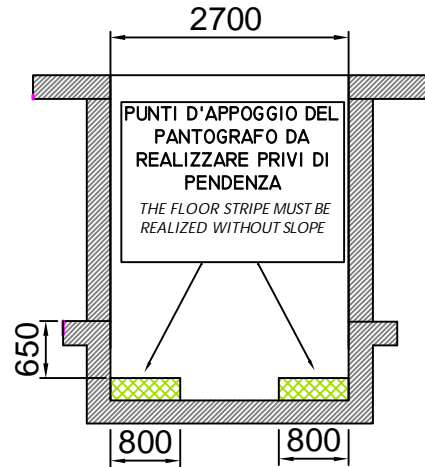

REALIZZARE LA FASCIA CENTRALE DELLA FOSSA LEGGERMENTE IN PENDENZA PER PERMETTERE LO SCOLO DELL'ACQUA PIOVANA ALL'INTERNO DEL POZZETTO DI RACCOLTA
REALIZED THE CENTRAL STRIPE WITH A MINIMAL SLOPE TO ALLOW THE DRAINAGE OF THE WATER IN THE RAINWATER COLLECTION

IL FONDO DELLA FOSSA PUO' ESSERE REALIZZATO CON UN PIANO UNIFORME DI CALCESTRUZZO ARMATO COMPLETAMENTE PRIVO DI PENDENZA, OPPURE RISPETTANDO I DUE PUNTI D'APPOGGIO RAFFIGURATI NELLA VISTA IN PIANTA.
THE BOTTOM OF THE PIT CAN BE PRODUCED USING A HOMOGENEOUS FREE SLOPE PLATFORM OF REINFORCED CONCRETE, OR RESPECTING THE TWO FULCRUMS AS SPECIFIED IN THE MAP VIEW

CARICHI STRESSES

	N1	33 kN	3300 Kg
LARGO	N1	33 kN	3300 Kg
EXTRALARGO	N1	35 kN	3500 Kg

PUNTI D'APPOGGIO IN CEMENTO ARMATO
REINFORCED CONCRETE FULCRUMS



POZZETTI DI RACCOLTA ACQUA PIOVANA
RAINWATER COLLECTION PIT



MONTAUTO: DISPOSITIVI DI SICUREZZA PRESENTI

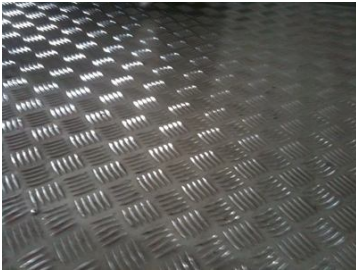

- PIANALE RIVESTITO IN LAMIERA ZINCATA A CALDO STRIATA O BUGNATA CON RILIEVO TIPO "MANDORLATO".
- IMPIANTO ELETTRICO IN BASSA TENSIONE (24 VOLT) CON FUNZIONAMENTO AD "UOMO PRESENTE".
- TUBAZIONI IN ACCIAIO CATEGORIA R2.
- DISPOSITIVO MECCANICO DI SICUREZZA PER MANUTENZIONI.
- VALVOLA DI BLOCCO CONTRO IL RISCHIO DI ROTTURA CIRCUITO IDRAULICO.
- VALVOLA DI MASSIMA PRESSIONE PER SOVRACCARICHI.
- VALVOLE DI TENUTA MONTATE DIRETTAMENTE SUI MARTINETTI DI SPINTA.



- PLATFORM COVERED BY A STRIPED OR SICEPPED FLOOR BOTH HOT DEEP GALVANIZED
- ELECTRICAL WIRING IN LOW TENSION 24V WITH FUNCTIONING WITH DEAD MAN SWITCH.
- STEEL PIPES R2 CATEGORY
- MECHANICAL SAFETY DEVICE USED IN MAINTENANCE
- LOCKING VALVE AGAINST THE RISK OF HYDRAULIC CIRCUIT DAMAGES
- MAXIMAL PRESSION VALVE REQUIRED FOR OVERLOAD
- SAFETY VALVE FIXED DIRECTLY ON THE CYLINDERS

VANO MONTAUTO: DISPOSITIVI DI SICUREZZA PRESENTI



- PARAPETTO IN ACCIAIO O IN MURATURA DI ALTEZZA NON INFERIORE AD 1200mm POSIZIONATO A FILO DELLA FOSSA.
- PULSANTIERE DI COMANDO A TENUTA STAGNA, POSIZIONATE ALL'ESTERNO DELLA MACCHINA IN POSIZIONE FAVOREVOLE AD UN CONTROLLO DELLE MANOVRE DI MOVIMENTAZIONE, COMPLETE DI LAMPEGGIANTE CON PULSANTI LUMINOSI DI SEGNALAZIONE PIANI, CHIAVE ESTRAIBILE E PULSANTE DI EMERGENZA.
- LE PROTEZIONI AI PIANI SONO DOTATE DI SERRATURA ELETTROMECCANICA OMOLOGATA
- SEZIONATORE GENERALE DI ALIMENTAZIONE ELETTRICA MUNITO DI DISPOSITIVO DI CHIUSURA PER IMPEDIRE L'AZIONAMENTO DA PARTE DI PERSONALE NON AUTORIZZATO.
- FORNIRE UNA ADEGUATA ILLUMINAZIONE SU ENTRAMBI I PIANI DI CARICO IN MODO DA OTTENERE UNA BUONA VISIONE DELLE MANOVRA DI MOVIMENTAZIONE
- FERMARUOTA MECCANICO PER CORRETTO POSIZIONAMENTO DELLA VETTURA



- PARAPET MADE IN STEEL OR IN CONCRETE WITH HEIGHT OF 1200mm POSITIONATED PARALLEL TO THE EDGE OF THE PIT
- WATERTIGHT CONTROL PANELS , PLACED OUTSIDE OF THE MACHINE IN FAVOURABLE POSITION TO HAVE A GOOD CONTROL OF THE HANDURING OPERATIONS IT HAS GOT FLASHING INDICATORS, EMERGENCY BUTTON AND REMOVABLE KEY
- MECHANICAL BLOCKING WHEELS USED TO PLACE CORRECTLY THE CAR ON THE PLATFORM
- ADEQUATE ILLUMINATION AT BOTH FLOOR NECESSARY TO SEE VERY WELL ALL THE MANOUVRES
- PROTECTIONS AT THE FLOORS HAVE GOT AN ELECTRICAL HOMOLOGATED LOCK.
- GENERAL ELECTRICITY SWITCH WITH CLOSING DEVICE TO PREVENT OPERATION BY UNAUTHORIZED PEOPLE